



Type(s)
Project
Date
Notes

GENERAL INFORMATION

ETC, the market leader in automated luminaire innovation, brings you the next generation hallmark of white light framing fixtures. High End Systems Halcyon Titanium, the middle product in the Halcyon Framing family of fixtures, is an earth shattering luminaire with over 40,000 lumens of output in a 76 lb frame. Outperforming fixtures of the past by 15,000 lumens and 20 lb, Halcyon Titanium also has an extreme feature set with everything a user needs to light shows of all shapes and sizes.

Applications

- Houses of worship
- Small to medium-sized performance venues
- Cruise ships and themed entertainment
- Production rental companies
- Trade show and ballroom AV
- Studio and film

Product Features

- Bright white LED engine
- 600 W Ultra-Bright engine
- Fixture output exceeding 40,000 lumens
- High quality 13-lens optic system
- Extremely powerful 6°–60° zoom
- Optimized CMY and CTO color mixing for even hue control
- Six position plus open color wheel
- Full-curtain framing system for total control of beam shaping
- 16-blade iris for extremely tight beam effects
- Trifusion frost system with linear insertion from light to heavy and everything in between
- Two, 7 position plus open Rotating Gobo Wheels
- Dual prisms for compound beam and projection effects
- Rotating Animation Wheel with linear positioning and angular control

ORDERING INFORMATION

Model	Description
HAL-T-UB-MI	Halcyon Titanium, Black, Ultra-Bright in Molded Insert, Boxed
HAL-T-HF-MI	Halcyon Titanium, Black, Ultra-Bright in Molded Insert, Boxed
RC-HAL-T	Road Case, Holds up to Two (2) Halcyon Titanium Fixtures in Molded Insert

Color Options: Fixtures ship standard in black. White available by request.
Included Accessories: Fixture includes two (2) Omega brackets, one (1) fixture power cord, bare ends to powerCON® TRUE1® TOP input, and a safety cable.

Accessories

Model	Description
HAL-T-SNOOT	Top Hat, Snoot for Halcyon Titanium
2500B7029-A	Fixture Power Cord Upgrade, 5 ft TRUE1 TOP to Parallel Blade U-Ground (Edison)
2560B7005	Fixture Power Cord Upgrade, Stage Pin to powerCON TRUE1 TOP, 20 A
2560B7006	Fixture Power Cord Upgrade, L6-20 to powerCON TRUE1 TOP, 20 A
2560B7007	Fixture Power Cord Upgrade, L5-20 to powerCON TRUE1 TOP, 20 A
67040007	MegaClaw™
55040014	Cheeseborough 2") Alloy 1/2 Coupler Truss Clamp
67040010	Mini-Claw™



PRODUCT SPECIFICATIONS

Source

Engine	Ultra-Bright	High Fidelity
LED Details	600 W	600 W
Field Lumens	See photometrics on page 4	
Max Integrating Sphere Lumens	40,000 lumens	24,000
LPW	66	40
LED Life	50,000 hours	50,000 hours
Native CCT	6700 K	6000 K

Color

Color Mixing	Cyan, magenta, yellow, CTO
Color Temperature	Variable down to 2200 K
Color Wheel	Six (6) dichroic colors plus open

Optical

Beam Angle Range	6°–60°
Gate Size	26 mm
Aperture Size	144 mm
Pattern Projection	Two rotating and indexable wheels with seven (7) interchangeable patterns plus open on each
Animation	- Bi-directional rotating animation wheel with linear insertion, and variable angle - LED Animation
Prism	Five facet star and four facet linear rotating prism with simultaneous insertion
Diffusion	Light, Medium, and Heavy frost seamlessly controlled with Trifusion control.
Iris	16-blade iris
Framing	Four-plane, full-curtain framing system with 180° module rotation
Flicker Control/Hz Range	2.4 kHz and 16 kHz

Control

Input Method	DMX (5-pin) or Ethernet
Protocols	DMX via RS-485 Art-Net or sACN via Ethernet
Ethernet Pass-Thru	Passive Ethernet in and thru with and without power
Data Conversion	Patented data conversion system for Ethernet to DMX
Modes (Footprint)	Standard (60 channels)
RDM Functions	Yes
UI Type	Full-color graphical UI with touch screen and 5-button navigational control
Local Control	Yes
Dimming Performance	16-bit, DMX controlled

Notes: All LED sources experience some lessening of light output and some color shift over time. LED output will vary with thermal conditions. Thermal conditions can be affected by ambient temperatures and orientation.

Electrical

Voltage Range	100–240 V 50–60 Hz
Input Method	powerCON TRUE1 TOP
Wattage (Standard)	1126 W
Current (Max)	11.3 A @ 100 V
Inrush (First Half Cycle)	120 V: 69 A 230 V: 123 A
Fixtures per Circuit	1 fixture (15 A power thru connector) 1 fixture (R20 module or similar) Note: TRUE1 TOP connector rated for 20 A (120 V / 60 Hz) and 16 A (240 V / 50 Hz)

Thermal

Ambient Operating Temp	-10°–40°C (14°–104°F)
Fan Mode	Standard, Studio, and Linear Continuous control channel

Physical

Pan and Tilt Range	542° pan, 258° tilt
Max Pan/Tilt Speed	360° in 2.54 s / 180° in 1.67 s
Materials	Steel and aluminum frame with molded plastic covers
Color Options	Black, white by request
Mounting Options	Any orientation
IP Rating	IP20
Weight	34.5 kg (76 lb)
Included Accessories	powerCON TRUE1 TOP to bare end fixture tail Two (2) clamp brackets Safety cable

Warranty

Fixture Warranty	Five (5) years for light engine Two (2) years for complete fixture
Warranty Details	etcconnect.com/Support/Warranty.aspx

Regulatory & Compliance

Approved regulatory standards	cETLus Listed Listed to UL 1573 Certified to CSA STD. C22.2 No: 166 CE Compliant UKCA Compliant
Complies to the ROHS directive	Yes

Safety

Safety	Minimum distance to illuminated surface = 3.0 m (9.8 ft) Minimum distance from fixture head to combustible materials = 0.1 m (4.0 in)
--------	--

FEATURE DETAILS

Rotating Gobo Details

Outside Diameter	30.0 mm (1.18 in)
Image Diameter	21 mm (0.82 in)
Materials	0.5 mm aluminum 1.1 mm glass Borofloat®

Rotating Gobo Wheel 1

1 - Wiggle Lines

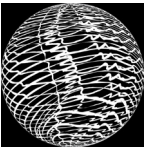

2 - Mycelium



3 - Bob's Brush

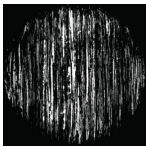

4 - The Claw

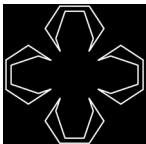

5 - Cut Cone

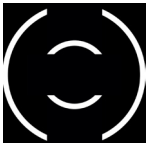

6 - Split-S



7 - Ice

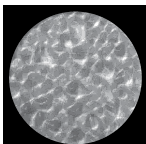

Rotating Gobo Wheel 2

1 - Texture Drops

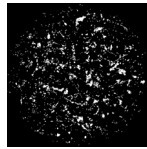

2 - Lovely Bubbly

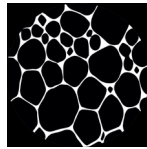

3 - Art Ducko

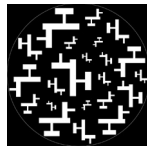

4 - Window Matrix

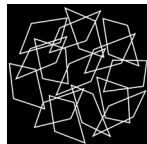

5 - Swirly Gig

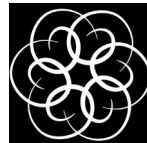

6 - Fenced In

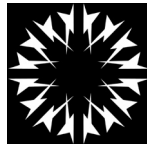

7 - The Only Way Is Up

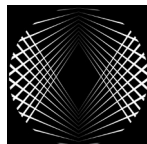

Color Wheel Details

Shape	Interchangeable wedge
Materials	1.1 mm glass Borofloat

1 - Red



2 - Blue



3 - TM-30



4 - Orange



5 - Dark Blue



6 - CTB



Prism Details

Movement	Two prism flags with individual or simultaneous insertion
Materials	Molded optical glass

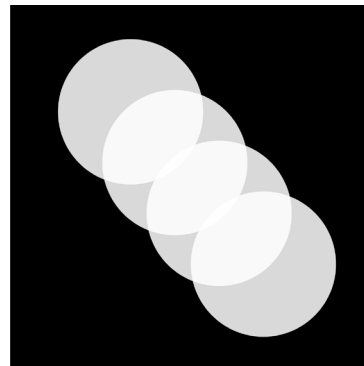
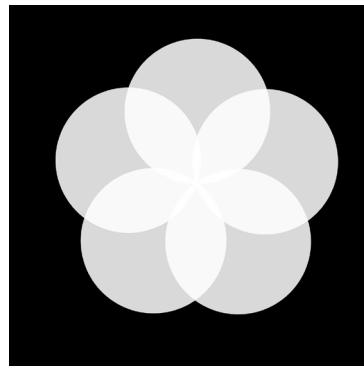

Animation Wheel Details

Movement	Bi-directional continuous rotation Linear insertion with 80° angular path range
Materials	0.8 mm aluminum

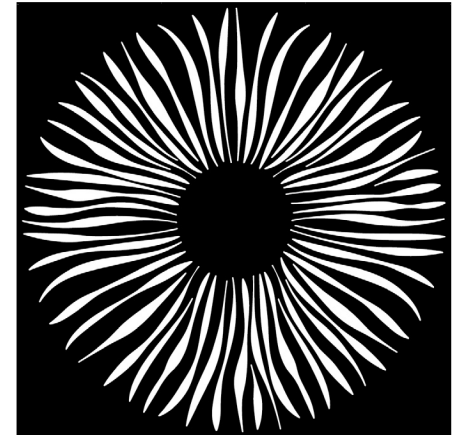

PHOTOMETRIC DATA

Halcyon Titanium - Ultra-Bright

	Degree	Candela	Field Lumens	Power Usage	Lumens Per Watt
Narrow	6°	2,160,400	12,652	600 W	21
Medium	26°	272,700	31,712	600 W	53
Wide	60°	77,000	34,112	600 W	57

Narrow - 6°

Throw Distance	10 ft 3.0 m	20 ft 6.1 m	30 ft 9.1 m	50 ft 15.2 m	200 ft 61 m
Field Diameter	1.0 ft 0.32 m	2.1 ft 0.64 m	3.1 ft 0.96 m	5.2 ft 1.60 m	21.0 ft 6.39 m
Illuminance (fc)	21,604	5,401	2,401	865	55
Illuminance (lux)	232,454	58,114	25,828	9,298	581

Medium - 26°

Throw Distance	10 ft 3.0 m	20 ft 6.1 m	30 ft 9.1 m	50 ft 15.2 m	200 ft 61 m
Field Diameter	4.6 ft 1.41 m	9.2 ft 2.81 m	13.9 ft 4.24 m	23.1 ft 7.05 m	92.3 ft 28.14 m
Illuminance (fc)	2,727	682	303	110	7
Illuminance (lux)	29,333	7,333	3,259	1,173	73

Wide - 60°

Throw Distance	10 ft 3.0 m	20 ft 6.1 m	30 ft 9.1 m	50 ft 15.2 m	200 ft 61 m
Field Diameter	11.5 ft 3.51 m	23.1 ft 7.05 m	34.6 ft 10.55 m	57.7 ft 17.59 m	230.9 ft 70.38 m
Illuminance (fc)	770	193	86	31	2
Illuminance (lux)	8,277	2,069	920	331	21

To determine center beam illumination in footcandles at any throw distance, divide candela by the throw distance squared.

Metric conversions: For meters, multiply feet by 0.3048.
For lux, multiply footcandles by 10.76.

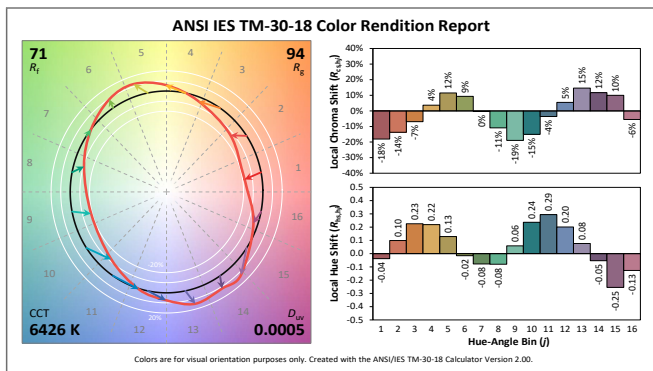

Additional Color Metrics	
CRI R_a (R_g)	71 (-29)
TLCI	46

Halcyon Titanium - High Fidelity

	Degree	Candela	Field Lumens	Power Usage	Lumens Per Watt
Narrow	6°	1,061,400	8,348	600 W	14
Medium	26°	145,400	19,426	600 W	32
Wide	60°	26,700	21,701	600 W	36

Narrow - 6°

Throw Distance	10 ft 3.0 m	20 ft 6.1 m	30 ft 9.1 m	50 ft 15.2 m	200 ft 61 m
Field Diameter	1.0 ft 0.32 m	2.1 ft 0.64 m	3.1 ft 0.96 m	5.2 ft 1.60 m	21.0 ft 6.39 m
Illuminance (fc)	10,614	2,654	1,180	425	27
Illuminance (lux)	114,196	28,549	12,688	4,568	285

Medium - 26°

Throw Distance	10 ft 3.0 m	20 ft 6.1 m	30 ft 9.1 m	50 ft 15.2 m	200 ft 61 m
Field Diameter	4.6 ft 1.41 m	9.2 ft 2.81 m	13.9 ft 4.24 m	23.1 ft 7.05 m	92.3 ft 28.14 m
Illuminance (fc)	1,454	364	162	59	4
Illuminance (lux)	15,644	3,911	1,738	626	39

Wide - 60°

Throw Distance	10 ft 3.0 m	20 ft 6.1 m	30 ft 9.1 m	50 ft 15.2 m	200 ft 61 m
Field Diameter	11.5 ft 3.51 m	23.1 ft 7.05 m	34.6 ft 10.55 m	57.7 ft 17.59 m	230.9 ft 70.38 m
Illuminance (fc)	267	67	30	11	1
Illuminance (lux)	2,873	718	319	115	7

To determine center beam illumination in footcandles at any throw distance, divide candela by the throw distance squared.

Metric conversions: For meters, multiply feet by 0.3048.
For lux, multiply footcandles by 10.76.

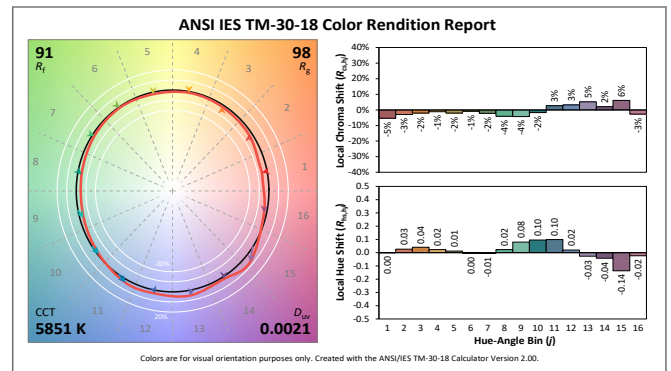

Additional Color Metrics	
CRI R_a (R_g)	93 (64)
TLCI	93

Product Dimensions

Model	Height		Width		Depth		Weight	
	in	mm	in	mm	in	mm	lb	kg
Halcyon Titanium**	28.4	720	18.0	456	11.6	294	76.0	34.5
Halcyon Titanium in Box with Molded Insert	23.0	584	22.0	536	28.0	559	103.0	46.7

**Does not include mounting hardware

Halcyon Titanium

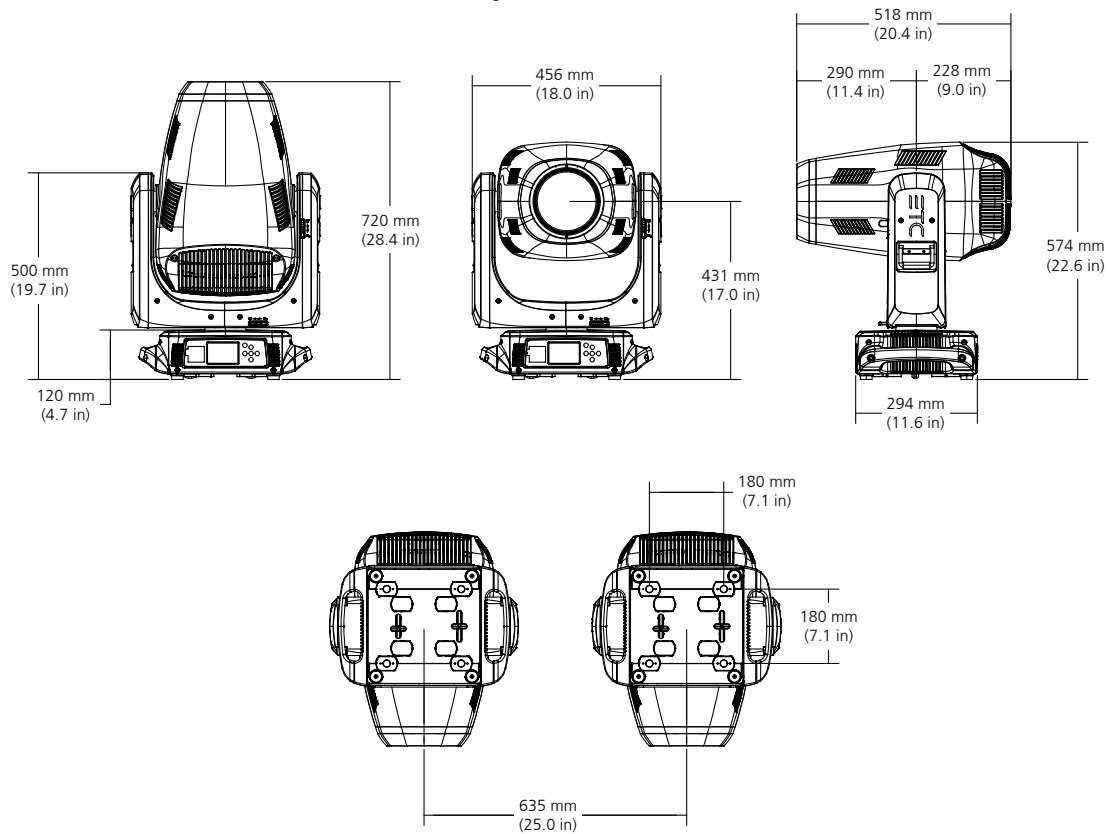

Power Table

VAC	Amps	Hz	Watts	VA	PF
100	11.3	50	1126	1140	0.99
120	9.2	60	1100	1109	0.99
200	5.4	50	1070	1073	0.98
208	5.2	60	1065	1079	0.98
220	4.8	50	1046	1070	0.98
230	4.7	50	1051	1065	0.98
240	4.5	60	1055	1070	0.97

ADDITIONAL ORDERING INFORMATION

Additional Accessories

Model Number	Description
H7500001	Extra Omega brackets

Molded Case Insert Dimensions

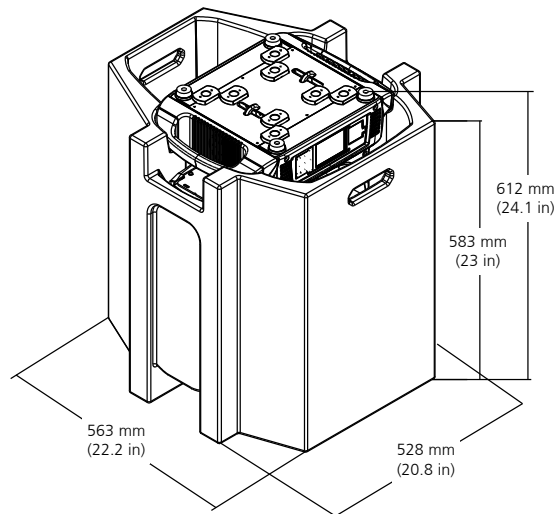

Optional Roadcase Dimensions

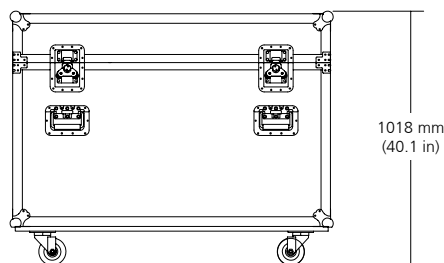
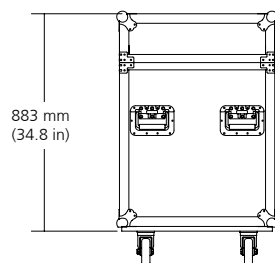
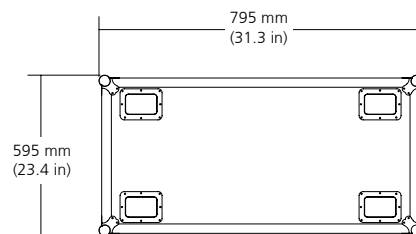

Corporate Headquarters • Middleton, WI USA

Global Offices • London, UK • Rome, IT • Holzkirchen, DE • Paris, FR • Hong Kong
Dubai, UAE • Singapore • New York, NY • Orlando, FL • Los Angeles, CA • Austin, TX

Copyright©2022 ETC. All Rights Reserved. All product information and specifications subject to change. Rev A 2022-11

*Trademark and patent info: etcconnect.com/ETC

etcconnect.com

